



**WORKPLACE**  
**SAFETY**  
A W A R E N E S S C O U N C I L

**Train-the-Trainers Guide to**  
**Electrical Safety**  
**For General Industry**

**A Review of Common OSHA Regulations and Workplace Violations**

**WWW.WPSAC.ORG**

## Table of Contents

Common Electrical Hazards .....	5
It's Your Life – Protect it!.....	5
How Much Electricity is Dangerous.....	5
Burn Hazards Associated With Electricity .....	6
Definition of “Arc Flash”.....	6
Typical Results from an Arc Flash.....	7
Approach / Protection Boundaries.....	7
How to Determine the Approach Boundaries .....	8
Nature of Electrical Accidents .....	9
Ways to Protect the Workers.....	9
What if we Can't Deenergize the Equipment.....	10
Lockout and Tagout .....	11
If You Must Work on Energized Circuits.....	12
Who is a Qualified Worker .....	12
Personal Protective Equipment.....	14
PPE for the Head .....	14
PPE for the Eyes & Face .....	16
PPE for the Body (FR Clothing).....	17
Inspection & Maintenance of FR Clothing.....	17
PPE for the Hands (Gloves) .....	18
Protective Glove Type's .....	18
Protective Glove Classification .....	19
Rotating Glove Colors .....	20
Maintenance of PPE .....	21
Glove Air Tests .....	22
Electrical Testing of Electrical Protective Equipment.....	22
Other Protective Equipment .....	23
Training Required for PPE.....	24
Re-training the Employee .....	24
How to Determine What PPE Must be Worn.....	25
Guidance From NFPA 70E .....	25
Hazardous (Classified) Locations .....	28
Hazardous Location Types.....	29
Hazardous Location Conditions.....	30
Nature of Hazardous Substances.....	31
An Alternate to Divisions.....	33



Groups Within the Zone .....	34
Zone or Division – Which Way Should I Go.....	34
Sources of Ignition .....	35
Equipment Design and Construction .....	35
Sealing of Equipment .....	38
Wiring Methods and GFCI .....	40
Protecting Employees.....	40
What is a GFCI .....	40
Where are Temporary GFCI's Required.....	40
Where are Permanent GFCI's Required .....	41
What About Protection on Other Systems .....	42
Are Extension Cords Allowable by OSHA.....	42
Permitted Use of Flexible Cords .....	42
Prohibited Use of Flexible Cords: .....	43
Inspections of Extension Cords .....	43
Overcurrent Protection Devices.....	44
Disconnecting Means of Motors .....	46
Cabinets, Boxes and Fittings.....	46
Other Prohibited Wiring Uses.....	46
Temporary Power and Lighting.....	47



This material was produced by the Workplace Safety Awareness Council, a 501(c)(3) not-for-profit organization dedicated to safety in the workplace. For further information about the council or upcoming safety related training, please visit our website at [www.wpsac.org](http://www.wpsac.org) or call us at (863) 537-4053.

This publication is designed to provide accurate and authoritative information about electrical hazards in the general industry workplace. It is provided with the understanding that the publisher is not engaged in rendering legal, accounting or other professional services. If legal or expert assistance is required, the services of a competent professional should be sought.

This material was produced under grant number SH-16615-07-60-F-12 from the Occupational Safety and Health Administration, U.S. Department of Labor. It does not necessarily reflect the views or policies of the U.S. Department of Labor, nor does mention of trade names, commercial products, or organizations imply endorsement by the U.S. Government.

### **Questions or Comments?**

Contact:

The Workplace Safety Awareness Council  
8350 McCoy Road  
Fort Meade, Florida 33841  
(863) 537-4053  
[www.wpsac.org](http://www.wpsac.org)



## Common Electrical Hazards

### **It's Your Life – Protect it!**

It's not a secret – electricity can be dangerous and when things go wrong lives can be at stake! According to the Bureau of Labor Statistics, 289 employees were killed by contact with electric current in 2002. This equates to more than one work related death every work day in America!

Between 1992 and 2001 an average of 4,309 employees lost time away from work because of electrical injuries. Even if an injured employee doesn't die as a result of their exposure to electricity, the recuperation period can be long, painful and expensive.

The goal of this training module is to keep employees health and maintain a quality of life that we all deserve!

### **How Much Electricity is Dangerous**

Current through the body, even at levels as low as 3 milliamperes, can also cause injuries of an indirect or secondary nature in which involuntary muscular reaction from the electric shock can cause bruises, bone fractures and even death resulting from collisions or falls (i.e. fall from a ladder after receiving a small shock).

<b>Current</b>	<b>Effect</b>
0.5 - 3 mA	Tingling sensations
3 – 10 mA	Muscle contractions (painful)
10 – 40 mA	“Can't Let Go” phenomena
30 – 75 mA	Respiratory paralysis (possibly fatal)
100 – 200 mA	Ventricular fibrillation (likely fatal)
200 – 500 mA	Heart clamps tight
1.5 A	Tissue and organs begin to burn

*Typical effects on the human body based on exposure*



**Fast Fact:** A 15 amp circuit breaker was designed to protect equipment – not people!

### **Burn Hazards Associated With Electricity**

Human skin provides great protection from normal elements; however human skin provides poor protection from extreme heat which is a byproduct of exposure to electricity. Typically there exist three types of burns:

Electrical burns happen when electric current flows through tissues and organs.

Arc burns result from high temperatures (up to 35,000 F) when an arc flash event occurs.

Thermal burns typically happen when skin touches a hot surface

**Fast Fact:** It doesn't take much for human skin to burn – in fact an exposure of 203 F for just one-tenth of a second (6 cycles) is enough to cause a third degree burn!

### **Definition of “Arc Flash”**

Simply put, an arc flash is a phenomenon where a flashover of electric current leaves its intended path and travels through the air from one conductor to another, or to ground.

The results are often violent and when a human is in close proximity to the arc flash, serious injury and even death can occur.



Arc flash can be caused by many things including:

- Dust
- Dropping tools
- Accidental touching
- Condensation
- Material failure
- Corrosion
- Faulty Installation

Three factors determine the severity of an arc flash injury:

- Proximity of the worker to the hazard
- Temperature
- Time for circuit to break

Because of the violent nature of an arc flash exposure when an employee is injured, the injury is serious – even resulting in death. It's not uncommon for an injured employee to never regain their past quality of life. Extended medical care is often required, sometimes costing in excess of \$1,000,000.

### **Typical Results from an Arc Flash**

- Burns (Non FR clothing can burn onto skin)
- Fire (could spread rapidly through building)
- Flying objects (often molten metal)
- Blast pressure (upwards of 2,000 lbs. / sq.ft)
- Sound Blast (noise can reach 140 dB – loud as a gun)
- Heat (upwards of 35,000 degrees F)

### **Approach / Protection Boundaries**

The National Fire Protection Association (NFPA) has developed specific approach boundaries designed to protect employees while working on or near energized equipment. These boundaries are:

- Flash Protection Boundary (outer boundary)
- Limited Approach
- Restricted Approach
- Prohibited Approach (inner boundary)



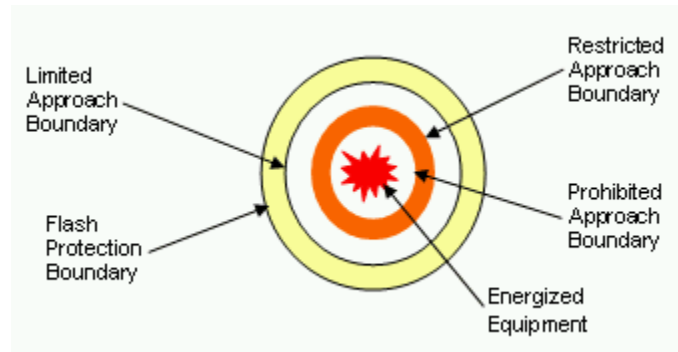

**Flash Protection Boundary** (outer boundary): The flash boundary is the farthest established boundary from the energy source. If an arc flash occurred, this boundary is where an employee would be exposed to a curable second degree burn (1.2 calories/cm<sup>2</sup>)

**Limited Approach:** An approach limit at a distance from an exposed live part where a shock hazard exists.

**Restricted Approach:** An approach limit at a distance from an exposed live part which there is an increased risk of shock.

**Prohibited Approach** (inner boundary): A distance from an exposed part which is considered the same as making contact with the live part.

This distance is not common between equipment. Some equipment will have a greater flash protection boundary while other equipment will have a lesser boundary.

### How to Determine the Approach Boundaries

Since different equipment will have different approach boundaries, calculations must be made on each piece of equipment. There exists a number of ways to establish these boundaries and the method you select depends on personal preference, resources available and quality desired.





Here are a few of the methods available:

NFPA Tables: Refer to NFPA 70E – 2000 Table 3-3.9.1 or Table 130.7(C)(9)(a) NFPA 70E – 2004.

Since you're referring to established tables, this method is the easiest and quickest however it provides the least amount of accuracy.

Formula Method: NFPA 70 E and IEEE Standard 1584 provides formulas that can be used to accurately determine the approach boundaries. This method is time consuming, requires an engineer level of expertise and is subject to human error.

Approach Calculator: IEEE has provided a spreadsheet based calculator to assist in determining approach boundaries. Although this calculator does help expedite the calculations, detailed information about the equipment and circuit is still required and this often necessitates the use of an electrical engineer.

Software: There exists on the market various software products that can simplify and expedite the approach boundary calculations. The software may also be able to create one-line diagrams and approach boundary warning labels as required by NFPA 70E.

## **Nature of Electrical Accidents**

Electrical incidents are caused by many different events; however we can identify three common root causes for just about any electrical incident:

- Working on unsafe equipment and installations;
- Unsafe Environment (i.e. wet environment / presence of flammable vapors); and
- Unsafe work performance

## **Ways to Protect the Workers**

There exists a number of ways to protect workers from the threat of electrical hazards. Some of the methods are for the protection of qualified employees doing work on electrical circuit and other methods are geared towards non-qualified employees who work nearby energized equipment.



Here are a few of the protective methods:

- De-energize the circuit
- Work Practices
- Insulation
- Guarding
- Barricades
- Ground Fault Circuit Interrupters (GFCI)
- Grounding (secondary protection)

Additionally, the use of alerting techniques are effective ways to warn employees (especially non-qualified) of the dangers present.

Alerting techniques might include safety signs, safety symbols, or accident prevention tags. Often times, the use of such signs alone is not adequate as an employee (especially a non-qualified employee) may accidentally come in direct contact with an energized circuit. In these instances a barricade shall be used in conjunction with safety signs.

A barricade is an effective way to prevent or limit employee access to work areas exposing employees to uninsulated energized conductors or circuit parts. Conductive barricades may not be used where they might cause an electrical contact hazard.

If signs and barricades do not provide sufficient warning and protection from electrical hazards, an attendant shall be stationed to warn and protect employees.

### **What if we Can't Deenergize the Equipment**

OSHA requires that live electrical parts be deenergized before the employee works on or near them, unless the employer can demonstrate that deenergizing introduces additional or increased hazards or is infeasible due to equipment design or operational limitations. [see 1910.333(a)(1)]

**Fast Fact:** Live parts that operate at less than 50 volts to ground need not be deenergized if there will be no increased exposure to electrical burns or to explosion due to electric arcs.



OSHA does understand that sometimes it is infeasible to deenergize electrical equipment and they have made allowances for this. This includes testing of electric circuits that can only be performed with the circuit energized.

Another example is work on circuits that form an integral part of a continuous industrial process in a chemical plant that would otherwise need to be completely shut down in order to permit work on one circuit or piece of equipment.

OSHA has also made allowances for not deenergizing electrical equipment when it would increase current hazards or create additional hazards, including such times as:

- interruption of life support equipment,
- deactivation of emergency alarm systems,
- shutdown of hazardous location ventilation equipment,
- removal of illumination for an area.

### **Lockout and Tagout**

Because a deenergized circuit can easily be energized while an employee is working on it, the circuits energizing the parts shall be locked out or tagged or both [see 1910.333(b)(2)]

Electric equipment that have been deenergized but have not been locked out or tagged shall be treated as energized parts [see 1910.333(b)(1)]

The employer must develop and maintain a written copy of the lockout / tagout procedures and make it available to employees. [see 1910.333(b)(2)(i)]

Only qualified persons may work on electric circuit parts or equipment that have not been deenergized. Such persons shall be capable of working safely on energized circuits and shall be familiar with the proper use of special precautionary techniques, personal protective equipment, insulating and shielding materials, and insulated tools. [see 1910.333(c)(2)]

**Fast Fact:** Once lockout / tagout has been applied to the circuit, a qualified person must verify that the equipment cannot be restarted.



## If You Must Work on Energized Circuits

If it has been determined that deenergizing a circuit is not feasible and the employee must work “hot”, the employer shall develop and enforce safety-related work practices to prevent electric shock or other injuries resulting from either direct or indirect electrical contacts.

The specific safety-related work practices shall be consistent with the nature and extent of the associated electrical hazards. [see 1910.333(a)]

These safety related work practices could include:

- Energized Electrical Work Permit
- Personal Protective Equipment
- Insulated Tools
- Written Safety Program

**Fast Fact:** The most effective and fool-proof way to eliminate the risk of electrical shock or arc flash is to simply deenergize the equipment.

## Who is a Qualified Worker

In an effort to limit electrical injuries in the workplace, the Occupational Safety and Health Administration (OSHA) has passed law that only allows a “Qualified” person to work on or around energized circuits or equipment.

Qualified person: One who has received training in and has demonstrated skills and knowledge in the construction and operation of electric equipment and installations and the hazards involved.

Note 1 to the definition of "qualified person:" Whether an employee is considered to be a "qualified person" will depend upon various circumstances in the workplace. For example, it is possible and, in fact, likely for an individual to be considered "qualified" with regard to certain equipment in the workplace, but "unqualified" as to other equipment.

Note 2 to the definition of "qualified person:" An employee who is undergoing on-the-job training and who, in the course of such training, has demonstrated an ability to perform duties safely at his or her level of training and who is under the



direct supervision of a qualified person is considered to be a qualified person for the performance of those duties.

Additional requirements for qualified persons. Qualified persons (i.e. those permitted to work on or near exposed energized parts) shall, at a minimum, be trained in and familiar with the following:

- The skills and techniques necessary to distinguish exposed live parts from other parts of electric equipment.
- The skills and techniques necessary to determine the nominal voltage of exposed live parts, and
- The clearance distances specified in 1910.333(c) and the corresponding voltages to which the qualified person will be exposed.

Type of training. The training required by this section shall be of the classroom or on-the-job type. The degree of training provided shall be determined by the risk to the employee.

**Fast Fact:** It's the employer's responsibility to determine the training required and to ensure that the employee is adequately training for the tasks undertaken.



## Personal Protective Equipment

Personal Protective Equipment is an integral part of any employer's safety program. OSHA has determined that PPE although a good way to protect employees, should be used as a last line of defense and its important to understand the limitations of PPE in the workplace.

Prior to using PPE, the employer must determine if other mans of protection are available. OSHA uses the following sequence for employee protection:

- Engineering Controls (deals with equipment)
- Administrative Controls (deals with people or processes)
- Personal Protective Controls (deals with what you wear)

If no other method is available to protect employees, then PPE is an acceptable method.

For those employees working in areas where there are potential electrical hazards, they must be provided with (and must use) electrical protective equipment that is appropriate for the specific parts of the body to be protected and for the work to be performed. [see 1910.335(a)(1)(i)]

### **PPE for the Head**

Employees must wear nonconductive head protection wherever there is a danger of head injury from electric shock or burns due to contact with exposed energized parts [see 1910.335(a)(1)(iv)].

#### ANSI Z89.1-1986

OSHA requires that protective helmets purchased after July 5, 1994, must comply with the performance guidelines in the ANSI Z89.1-1986, American National Standard for Personal Protection—Protective Headwear for Industrial Workers Requirements or shall be demonstrated to be equally effective.

**FAST FACT:** ANSI has revised its Z89.1 standard a few times since 1986 and its most current standard is ANSI Z89.1-2003. OSHA however, still references the 1986 standard. As a practical matter if you comply with any of the ANSI Z89.1 standards from 1986 onward, you are compliant with OSHA.



ANSI Z89.1-1986 separates protective helmets into two different types and three different classes.

**Type 1** helmets incorporate a full brim (brim fully encircles the dome of the hat)

**Type 2** helmets have no encircling brim, but may include a short bill on the front

Regarding electrical performance, ANSI Z89.1-1986 recognizes three classes:

**Class A Helmets** reduce the force of impact of falling objects and also reduce the danger of contact with exposed low-voltage electrical conductors. Helmet shells are proof-tested at 2,200 volts of electrical charge.

**Class B Helmets** reduce the force of impact of falling objects and also reduce the danger of contact with exposed high-voltage electrical conductors. Helmet shells are proof-tested at 20,000 volts.

**Class C Helmets** reduce the force of impact of falling objects, but offer no electrical protection.

Every protective helmet that conforms to the requirements of ANSI Z89.1-1986 must be appropriately marked to verify its compliance. The following information must be marked inside the hat:

- Manufacturer's name
- The "ANSI Z89.1-1986" designation
- Class designation (A, B or C)

#### ANSI Z89.1-1997

In 1997 ANSI revised its head protection standard. The 1997 version of ANSI Z89.1 contains a few notable changes.

ANSI Z89.1-1997 no longer uses Type 1 and Type 2 to describe the brim characteristics of a protective helmet. The new Type designation is as follows:

**Type I** helmets offer protection from blows to the top of the head

**Type II** helmets offer protection from blows to both the top and sides of the head

ANSI Z89.1-1997 also changed the class designations for protective helmets.



Under Z89.1-1997, the following three classes are recognized:

- **Class G (General) Helmets** -This is equivalent to the old Class A. Class G helmets are proof tested at 2,200 volts.
- **Class E (Electrical) Helmets** - This is equivalent to the old Class B. Class E helmets are proof tested at 20,000 volts.
- **Class C (Conductive) Helmets** - This class provides no electrical insulation; the class designation did not change from the old standard.

Every protective helmet that conforms to the requirements of ANSI Z89.1-1997 must be appropriately marked to verify its compliance. The following information must be marked inside the hat:

- Manufacturer's name
- The "ANSI Z89.1-1997" designation
- Class designation (G, E or C)
- Date of manufacture

Also instructions related to maintenance of the helmet, sizing and service life guidelines must also accompany the protective helmet.

#### ANSI Z89.1-2003

The most current ANSI standard is Z89.1-2003 and most new protective helmets will reference this current standard. In this revision ANSI made an effort to align with other national standards. The Type and Class designations are the same as the 1997 standard.

#### **PPE for the Eyes & Face**

Employees shall wear protective equipment for the eyes or face wherever there is danger of injury to the eyes or face from electric arcs or flashes or from flying objects resulting from electrical explosion. [see 1910.335(a)(1)(v)]

When working on energized parts, the possibility of arc flash exists and the employee must be protected. Dangers could include heat, flying hazards and molten metal, therefore the PPE must be durable, non-conductive, heat resistant and provide deflection qualities.





As with much of the arc flash PPE, the heat resistance is measured in calorie/cm<sup>2</sup>. Remember an unprotected worker exposed to a 1.2 cal/cm<sup>2</sup> energy burst would result in second degree burns.

### **PPE for the Body (FR Clothing)**

As we learned earlier, employees working in areas where there are potential electrical hazards must be provided with, and must use, electrical protective equipment that is appropriate for the specific parts of the body to be protected and for the work to be performed [see 1910.335(a)(1)(i)]. This would include flame resistant (FR) clothing.

During an arc flash event the temperatures can reach an excess of 35,000 degrees. Even at temperatures much lower, typical daily wear clothing would do little to protect the worker from being seriously injured. In fact, at such high temperatures, the clothing will ignite and continue to burn on the body well after the arc flash has dissipated. This is where serious injury and death often occur.

To counteract the extreme heat from an arc flash, FR clothing is required. FR clothing can take the form of pants, shirts, coveralls, jackets, parkas and full flash suits. Obviously, fit, comfort and flexibility are important but the greatest indicator of adequate FR clothing for a given task is based on the “arc thermal performance value” (ATPV).

The ATPV is incident energy on a material that results in sufficient heat transfer through the fabric or material to cause the onset of a second degree burn. Manufacturers of FR clothing will provide an ATPV rating on their clothing and you must match the ATPV with the potential exposures in the workplace.

### **Inspection & Maintenance of FR Clothing**

When inspecting and maintaining FR clothing, you must always follow the manufactures recommendations; however here are a few basic guidelines:

- Do not use fabric softeners, starches or bleaches when washing
- Wash FR clothing separate from other laundry
- Wash at low temperature (110° – 120° F maximum)
- Tumble dry at the lowest setting possible

FR clothing must be visually inspected before each use; however additionally inspections during the work day may be necessary. FR clothing that becomes



contaminated with grease, flammable liquids etc shall be removed and sent to be laundered.

**FAST FACT:** Clothing made from acetate, nylon, polyester, rayon (alone or in blends) is prohibited when employees are working around energized electrical parts, unless the employer can demonstrate that the fabric has been treated to withstand the conditions that may be encountered or that the clothing is worn in such a manner as to eliminate the hazard involved.

### **PPE for the Hands (Gloves)**

Since employees working on energized electrical parts are using their hands, obviously that part of the body (hands and arms) are most susceptible to electric shock and must be protected.

Insulating gloves provide an excellent means of protecting the workers from accidental electrical contact. To be effective the insulating gloves must have high insulative qualities, while also being comfortable, durable and flexible.

Because safety is involved, the employer and employee must become familiar with the differences between the various types and classes of insulating gloves available.

**FAST FACT:** Design specifications and in-service care requirements for insulated gloves can be found in the American Society for Testing and Materials (ASTM) D 120-02 and F 496 standards.

### **Protective Glove Type's**

The Occupational Safety and Health Administration (OSHA) has identified design and in-service care and use standards for electrical protective equipment at 1910.137. Employers should become very familiar with this standard and ensure that employees understand it as well.



First, for insulating gloves there are two “Type’s”:

**Type I** glove is not ozone-resistant







**Type II** is ozone-resistant.

Ozone is a form of oxygen that is found in the air surrounding a conductor in high voltages. It can causes dangerous cracks to form in rubber products, including insulating gloves, thus rendering them unsafe. Type I rubber gloves can also be negatively affected by UV light so care should be taken to properly store and inspect these gloves.

The Type II gloves are not as susceptible to ozone and UV rays, however they are not as flexible as Type I and therefore more uncomfortable to wear.

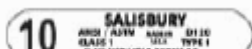
### Protective Glove Classification

Protective gloves are categorized into six classifications, each based on the approved voltage levels the gloves can provide protection for. It’s quite easy to determine the classification based on a color-coded tag found on the glove.

Voltage Classifications for Rubber Gloves				
Tag Color	Class	Proof Test Voltage AC / DC	Max. Usage Voltage AC / DC	Glove Tag
Beige	00	2,500 / 10,000	500 / 750	
Red	0	5,000 / 20,000	1,000 / 1,500	
White	1	10,000 / 40,000	7,500 / 11,250	
Yellow	2	20,000 / 50,000	17,000 / 25,500	
Green	3	30,000 / 60,000	26,500 / 39,750	
Orange	4	40,000 / 70,000	36,000 / 54,000	





**FAST FACT:** Remember, it's not the color of the glove that's important – it's the color of the tag!

### **Rotating Glove Colors**

Salisbury, a leading manufacturer of insulating gloves recommends an alternating glove color program to assure all gloves are in the proper test cycle per OSHA and ASTM requirements.

For example starting in January, use red gloves for the next six months. On July 1, remove the red gloves from the worksite and have them electrically tested as required and begin using black gloves for the remainder of the year. On January 1, remove all black gloves from service and go back to red gloves.

### **Leather Glove Protectors**

Leather protector gloves should always be worn over Rubber Insulating Gloves to provide the needed mechanical protection against cuts, abrasion and punctures.

Proper care of leather protectors is essential to user safety. Inspect them for metal particles, imbedded wire, abrasive materials or any substance that could physically damage the rubber gloves.



**FAST FACT:** Do not use leather protectors alone for protection against electric shock. Serious injury or death could result. Always use proper rubber insulating gloves.

### Glove Liners and Powder

Glove liners provide a more comfortable fit and reduce friction between the hand and the insulating glove. For additional comfort and ease of putting on and off, glove dust is recommended. Glove dust is a cooling, frictionless powder that absorbs moisture and perspiration when wearing rubber gloves.

### **Maintenance of PPE**

Protective equipment must be maintained in a safe, reliable condition and shall be periodically inspected or tested, as required by 1910.137 [see 1910.335(a)(1)(ii)]

When speaking of “inspected” OSHA is speaking of a very-frequent visual review of the equipment. When OSHA speaks of “testing” they are referring to something a little more detailed (see “Protective Equipment Testing Schedule” – Figure P-1)

Insulating equipment must be inspected for damage before each days use and anytime damage is suspected. Typical damage to insulating equipment might include the following:

- Embedded foreign objects (metal slivers, splinters)
- Holes, punctures, tears or cuts
- Ozone damage (fine cracks)
- Swelling, softening, sticky or hardening
- Damage from chemicals

Insulating equipment must also be stored in a way that does not damage the material. The following items can cause damage:

- Temperature extremes
- UV damage (from sunlight)
- Excessive humidity
- Ozone (UV rays, arcing)
- Foreign materials (oils, petroleum products, hand lotion, baby powder)



Proper storage extends the service life of gloves. Folds and creases strain natural rubber and cause it to cut from ozone prematurely. Storing rubber gloves in the right size bag and never forcing more than one pair into each bag will help equipment last longer.

### Glove Air Tests

Before each days use OSHA requires air testing on insulated gloves and ASTM F 496 provides details on how to perform the test. To conduct the test, fill the glove with air and hold against your cheek to feel for and hear releasing air.



A portable glove inflator is easy to use and provides a definite validation of the gloves integrity. The glove is secured to the inflator using a nylon strap and fastened with hook & pile or a rubber o-ring. Inflation is accomplished by pumping the bellows of the inflator against any smooth flat surface.

### Electrical Testing of Electrical Protective Equipment

Electrical protective equipment must undergo periodic electrical tests to ensure its protective qualities are still present. The American Society for Testing and Materials (ASTM) provides detailed information about the requires testing (see <http://www.astm.org>)

Protective Equipment Testing Schedule	
Equipment	When to Test
Gloves	Before first issue and every six months after that.*
Blankets / Sleeves	Before first issue and every 12 months after that.
Line Hose / Covers	Upon indication that insulating value is devalued.

Figure P-1

\* If the protective equipment has been electrically tested, but not issued for use it may not be placed in service unless it has been electrically tested within the previous 12 months.



## Other Protective Equipment

Based on the employee's exposure, other forms of PPE may be necessary. For instance if working in a toxic (including an oxygen deficient) environment, an employee would be required to provide the employee with respiratory protection [see 1910.134]. An employee working in areas that feature elevated noise levels, the employer must provide suitable hearing protection for the employee [see 1910.95].

Remember, it's up to the employer to conduct a job hazard analysis to determine what PPE is needed for a particular task. That hazard analysis must be certified by the employer and kept on record. [see 1910.132(d)(2)]

### Arc Suppression Blanket

Protective shields, protective barriers, or insulating materials shall be used to protect each employee from shock, burns, or other electrically related injuries while that employee is working near exposed energized parts which might be accidentally contacted or where dangerous electric heating or arcing might occur. [see 1910.335(a)(2)(ii)]



The Arc Suppression Blanket is used as a barrier for protection from the explosive and incendiary effects of electrical arcs and flashes. These hazardous electrical discharges can be caused by faults in cables, in cable splices and joints, and at transformer terminals, or they may be generated by the operation of switch gear, circuit breakers and lightning arrestors. The blanket can be used for worker protection in underground vaults, switchyards, and other locations where electrical equipment poses a risk of exposure to explosive electrical discharges. NOT an Electrically Insulating Blanket.

### Insulated Tools



When employees are working near exposed energized parts, they must use tools that are insulated to at least the level of the voltage levels they are exposed to. These tools must be inspected prior to each use for damage and if damage is identified they must be removed from service.



## **Training Required for PPE**

The employer shall provide training to each employee who is required to use PPE. The employee must be trained to know at least the following [see 1910.132(f)(1)(i)-(v)]:

- When PPE is necessary;
- What PPE is necessary;
- How to properly don, doff, adjust, and wear PPE;
- The limitations of the PPE; and,
- The proper care, maintenance, useful life and disposal of the PPE.

The employee shall demonstrate an understanding of the training and the ability to use PPE properly, before being allowed to perform work requiring the use of PPE [see 1910.132(f)(2)].

The employer must verify that each affected employee has received and understood the required training and certify in writing, the date(s) of training, name of the employee trained, and the subject trained [see 1910.132(f)(4)].

## **Re-training the Employee**

If an employer has reason to believe that an employee who has already been trained does not have the understanding and skill required, the employer must retrain the employee.

Examples of times when re-training is needed might include [see 1910.132(f)(3)(i)-(iii)]:

- Changes in the workplace render previous training obsolete; or
- Changes in the types of PPE to be used render previous training obsolete; or
- Inadequacies in an affected employee's knowledge
- Use of PPE indicate that the employee lacks understanding or skill.





## How to Determine What PPE Must be Worn

There does not exist a “one size fits all” requirement for the type of PPE that must be worn when working with electrical hazards. Different levels of hazards require different level of personal protection.

To compensate for these variables, OSHA requires that *“the employer shall assess the workplace to determine if hazards are present, or are likely to be present, which necessitate the use of personal protective equipment”* [see 1910.132(d)(1)].

Once a hazard is identified (i.e. exposed electrical parts) the employer:

*“shall verify that the required workplace hazard assessment has been performed through a written certification that identifies”* [see 1910.132(d)(1)]:

- the workplace evaluated;
- the person certifying that the evaluation has been performed;
- the date(s) of the hazard assessment; and
- identifies the document as a certification of hazard assessment.

This written certification must be performed for each piece of equipment worked on and be broken down into various tasks that will be performed (i.e. voltage testing, install circuit breaker).

## Guidance From NFPA 70E

Developing a written PPE certification or Job Hazard Analysis can be a difficult task; however NFPA 70E provides some very good guidance.



NFPA uses a three-step process as follows:

**Step 1:** Determine the Hazard / Risk Category Classification based on NFPA 70E Table 130.7(C)(9)(a)

Task	Hazard / Risk Category	V-Rated Gloves	V-Rated Tools
Panelboards & Switchboards >240V and up to 600V			
CB or Fuse Switch Operation With covers ON	0	No	No
CB or Fuse Switch Operation With covers OFF	1	No	No
Work on energized parts, including voltage testing	2*	Yes	Yes

These tables are used for demonstration purposes only.  
Always refer to NFPA 70E for actual requirements

2\* Indicates that a double layer switching hood and hearing protection is required in addition to other category 2 PPE requirements.

**Step 2:** Select Protective Clothing and Personnel Protective Equipment (PPE) Matrix based on NFPA 70E Table 130.7(C)(10).

Personal Protective Clothing	Hazard / Risk Category Number					
	-1	0	1	2	3	4
FR Clothing:						
Long-sleeved Shirt			X	X	X	X
Pants			X	X	X	X
Coverall			(Note 5)	(Note 7)	X (Note 9)	(Note 5)
Jacket, Parka, Rainwear			AN	AN	AN	AN

These tables are used for demonstration purposes only.  
Always refer to NFPA 70E for actual requirements

Personal Protective Equipment	Hazard / Risk Category Number					
	-1	0	1	2	3	4
FR Protective Equipment:						
Hard Hat			X	X	X	X
Safety Glasses	X	X	X	AL	AL	AL
Flash Suit Hood					X	X
Hearing Protection				X (note 8)	X	X

These tables are used for demonstration purposes only.  
Always refer to NFPA 70E for actual requirements



**Step 3:** Develop and affix an Arc Flash warning label to the equipment based on the arc flash analysis (using tables, formula or software)

This final step requires the employer to use field markings to warn qualified persons of potential electric arc flash hazards on equipment likely to require maintenance while energized.

Minimum arc flash label example

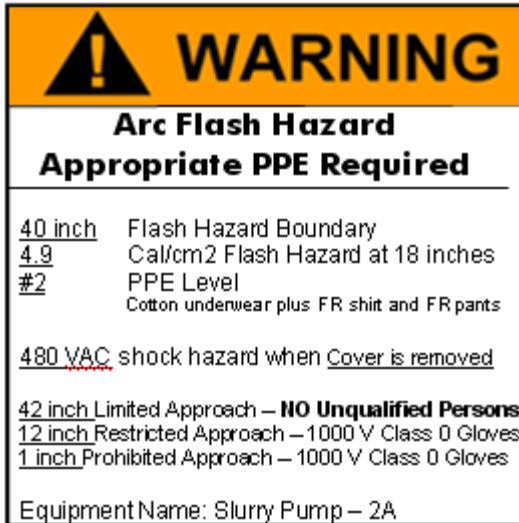

Detailed (preferred) arc flash label example



## Hazardous (Classified) Locations

Hazardous locations - also know as "Classified Locations" are an often misunderstood entity and therefore a source of constant under-protection.

The National Electrical Code (NEC) defines hazardous locations as those areas "where fire or explosion hazards may exist due to flammable gases or vapors, flammable liquids, combustible dust, or ignitable fibers or flyings."

Hazardous (classified) locations may be found in occupancies such as, but not limited to, the following:

- aircraft hangars,
- gasoline dispensing and service stations,
- bulk storage plants for gasoline or other volatile flammable liquids,
- paint-finishing process plants,
- health care facilities,
- agricultural or other facilities where excessive combustible dusts may be present,
- marinas,
- boat yards,
- petroleum and chemical processing plants
- textile mills

Since electrical equipment can become a source of ignition in hazardous locations, standards have been developed to provide classifications, installation methods and appropriate electrical equipment designations for these areas.

**Fast Fact:** An important feature of the revised Hazardous Classification rule is the requirement for employers to document the designation of hazardous locations within their facilities.

This allows workers who install, inspect, maintain, or operate equipment in these areas to identify the correct equipment or system components to be used to ensure worker safety.



Hazardous locations are classified in three ways by the National Electrical Code:

TYPE → CONDITION → NATURE

## Hazardous Location Types

We'll first examine the various "Types" of hazardous locations. There are three types of hazardous locations.



### Class I Locations

The first type of hazardous location is called a "Class I Location". This classification is created by the presence of flammable gases or vapors in the air in sufficient quantities to be explosive or ignitable.

When these materials are found in the atmosphere, a potential for explosion exists if an electrical or other source of ignition is present.

Some typical Class I locations are:

- Petroleum refineries, and gasoline storage and dispensing areas;
- Dry cleaning plants where vapors from cleaning fluids can be present;
- Spray finishing areas;
- Aircraft hangars and fuel servicing areas; and
- Utility gas plants, and operations involving storage and handling of liquified petroleum gas or natural gas.

### Class II Locations

The second type of hazardous location is called a "Class II Location". This classification is created by the presence of combustible dust in the air in sufficient quantities to be explosive or ignitable.



Some typical Class II locations are:

- Grain elevators;
- Flour and feed mills;
- Plants that manufacture, use or store magnesium or aluminum powders;
- Producers of plastics, medicines and fireworks;
- Producers of starch or candies;
- Spice-grinding plants, sugar plants and cocoa plants; and
- Coal preparation plants and other carbon handling or processing areas.

### Class III Locations

The third type of hazardous location is called a “Class III Location”. This classification is created by the presence of easily ignitable fibers or flyings. Typically these fibers and flyings are not suspended in the air, but can collect around machinery or on lighting fixtures and where heat, a spark or hot metal can ignite them. Some typical Class III locations are:

- Textile mills, cotton gins;
- Cotton seed mills, flax processing plants; and
- Plants that shape, pulverize or cut wood and create sawdust or flyings.

### **Hazardous Location Conditions**

After identifying the three types of hazardous locations, we next move to the actual “conditions” found within each of those three types of hazardous locations.

When hazards would be expected to be present in everyday production operations or during frequent repair and maintenance activity they are considered “normal conditions” and have been designated as “Division 1”

**For Example:** Good examples of Class I, Division 1 locations would be the areas near open dome loading facilities or adjacent to relief valves in a petroleum refinery, because the hazardous material would be present during normal plant operations.

When hazards are expected to be confined within closed containers or closed systems and will be present only through accidental rupture, breakage or unusual faulty operation they are considered “abnormal conditions” and have been designated as “Division 2”.



**For Example:** Closed storage drums containing flammable liquids in an inside storage room would not normally allow the hazardous vapors to escape into the atmosphere. But, what happens if one of the containers is leaking?

You've got a Class I, Division 2 (abnormal condition) hazardous location.

## Nature of Hazardous Substances

After identifying the three types of hazardous locations and the two possible conditions, we next move to the specific “nature” of the hazard in each hazardous location.

The nature of the hazard is expressed in “Groups” and these groups are specific to the Class designation of the hazardous locations. For instance a Class I location has four possible groups of specific hazards:

- Group A = acetylene
- Group B = hydrogen and other materials with similar characteristics
- Group C = ether and similar materials
- Group D = materials such as substances butane, gasoline, natural gas and propane

**Fast Fact:** These materials are grouped according to the ignition temperature of the substance, its explosion pressure, and other flammable characteristics.

In Class II locations (combustible dust) has three possible groups of specific hazards:

- Group E = Metal dusts such as aluminum & magnesium
- Group F = carbon black, charcoal dust, coal and coke dust
- Group G = grain dusts, flour, starch, cocoa, and similar types of materials

**Fast Fact:** These groups are classified according to the ignition temperature and the conductivity of the hazardous substance. Conductivity is an important consideration in Class II locations, especially with metal dusts.



NOTE: There are no specific groups for Class III locations

**For Example:** How would we classify a storage area where LP gas is contained in closed tanks?

LP gas is a Class I substance (gas or vapor). It's Division 2 because it would only be in the atmosphere if an accidental rupture or leakage occurred, and it is Group D material.

The table below summarizes the various hazardous (classified) locations.

<b>Summary of Class I, II, III Hazardous Locations</b>			
<b>Classes</b>	<b>Groups</b>	<b>Divisions</b>	
		<b>1</b>	<b>2</b>
<u>Class I</u> Gases, Vapors & Liquids	A: Acetylene B: Hydrogen, etc. C: Ester, etc. D: Hydrocarbons. fuels	Normally explosive and hazardous	Not normally present in an explosive concentration but may accidentally exist.
<u>Class II</u> Dusts	E: Metal dusts (conductive and explosive) F: Carbon dusts (some are conductive, all are explosive) G: Flour, starch, grain, combustible plastic or chemical dust (explosive)	Ignitable quantities of dust are or may be in suspension, or conductive dust may be present	Dust not normally suspended in an ignitable concentration (but may accidentally exist). Dust layers are present.
<u>Class III</u> Fibers & Flyings	Textiles, woodworking etc. (easily ignitable but not usually explosive)	Handled or used in manufacturing	Stored or handled in storage (exclusive of manufacturing)





## An Alternate to Divisions

Historically, Divisions have been used to differentiate between conditions within a Classification, however the 2000 edition of NFPA 70E incorporates an alternative way to designate Divisions.

The “Zone Classification” system is based on various European standards that were developed by the International Electrotechnical Commission (IEC). The IEC formalized this zone system, which is now used to classify the majority of the world's hazardous location systems.

**Fast Fact:** OSHA approves of either “Division Classification” or “Zone Classification”

The “Zone Classification System” (alternative method) is only applicable to Class I locations and it consists of three zones:

- Class I, Zone 0
- Class I, Zone 1
- Class I, Zone 2

A Class I, Zone 0 location is a location in which one of the following conditions exists:

- Ignitable concentrations of flammable gases or vapors are present continuously;
- Ignitable concentrations of flammable gases or vapors are present for long periods of time.

A Class I, Zone 1 location is a location in which one of the following conditions exists:

- Ignitable concentrations of flammable gases or vapors are likely to exist under normal operating conditions; or



- Ignitable concentrations of flammable gases or vapors may exist frequently because of repair or maintenance operations or because of leakage; or
- Equipment breakdown could cause release of flammable gases or vapors and breakdown would cause the electric equipment to become a source of ignition; or
- A location that is adjacent to a Class I, Zone 0 location from which ignitable concentrations of vapors could be communicated

A Class I, Zone 2 location is a location in which one of the following conditions exists:

- Ignitable concentrations of flammable gas or vapor not likely or for short period only; or
- Used but confined in closed systems or containers but could escape due to accident; or
- Ignitable accumulation prevented by positive ventilation; or
- Area adjacent to Class I Zone I from which ignitable concentrations could be communicated

### **Groups Within the Zone**

The zone system has three such groups, designated IIA (least volatile), IIB, and IIC (most volatile). Substances classified under groups A and B in the division system generally fall under group IIC of the zone system.

### **Zone or Division – Which Way Should I Go**

Hazardous locations and the equipment used within must be determined by a registered Professional Engineer and the determination to use the “Division” method or the “Zone” method will be based that Engineers preference and familiarity.

Either method is acceptable to OSHA.



## Sources of Ignition

Previously, we've established the fact that electrical equipment can become a source of ignition in a hazardous location. Typically there are three root causes of ignition:

- Arcs and sparks produced by the normal operation of equipment (i.e. motor starters, contactors, and switches)
- The high temperatures of some heat-producing equipment (i.e. lamps and lighting fixtures)
- Electrical equipment failure (i.e. shorting of a terminal)

**Fast Fact:** The National Electrical Code requires special marking of heat producing equipment with temperatures above 100°C (212°F).

## Equipment Design and Construction

Standards have been developed that identify what equipment may be used in the hazardous locations. As you might expect, what equipment you can install will be based on the Classification (i.e. Class I, Class II or Class III) of the hazardous location.

### Class I Requirements

In designing equipment for Class I locations (especially Division 1), it is assumed that the hazardous gases or vapors will be present and eventually seep into the enclosure, so there is a very real chance for an internal explosion to occur. Based on this assumption the first requirement for a Class I enclosure is strength and the equipment is typically referred to as being "explosion proof".

In the event of an ignition, the enclosure must be strong enough to contain the explosion within the enclosure and the internal strain created by the explosion must be absorbed.

Also, the enclosure must function at a temperature below the ignition temperature of the surrounding atmosphere. If the enclosure were to heat up above that ignition temperature an explosion would certainly occur.



### Flame Paths

In the event of an explosion within the enclosure, the equipment must provide a way for the burning gases to escape from the enclosure as they expand. This escape route is provided through what is commonly called a “flame path”.

**Fast Fact:** Burning gases within an enclosure must be allowed to escape but only after they have cooled and their flame has been extinguished. A correctly designed flame path will satisfy this requirement.

One type of flame path is the “ground surface” flame path. In this example the surfaces of the enclosure are ground, mated, and held to a tolerance of 15 ten-thousandths of an inch. This permits gases to escape, but only after they've been sufficiently cooled, so they won't ignite the volatile surrounding atmosphere.

Another kind of flame path is the threaded flame path. After an explosion, the gas travels out the tightly threaded joint . . . but as it does, it cools off.

Exploded gases may also escape around the shafts of operators used in the enclosure. But, here again, close tolerances are used to quench the burning gas.

Examples of a threaded flame path is shown below.

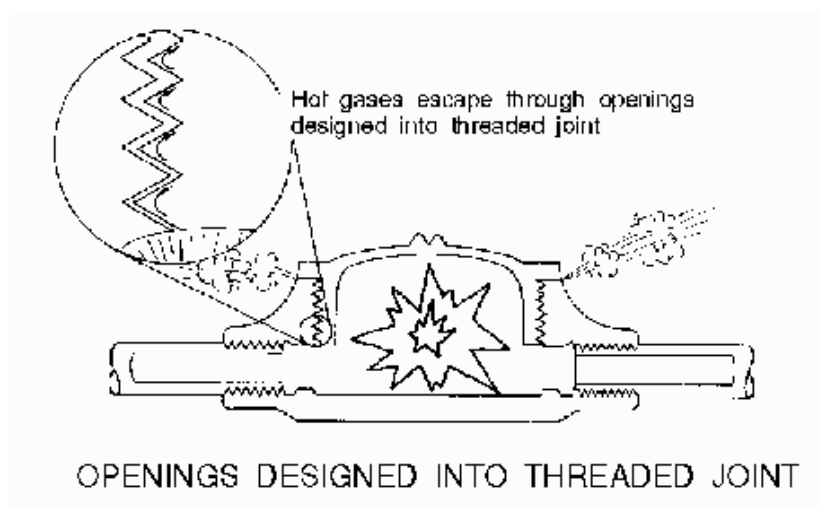

**Fast Fact:** Be very careful when shipping, handling, installing or maintaining explosion proof equipment. Even slight damage to a flame path can permit burning gases to escape, igniting the surrounding atmosphere.

### Class II Requirements

In Class II locations the hazard is not explosive gas or vapors, its ignitable dust and therefore the design criteria for equipment in a Class II location is unique.

Class II equipment is designed so that the explosive dust is kept away from equipment housed within the enclosure so that no internal explosion can take place. Although the dust may ignite, the concern for a heavy explosion (like with gas or vapor) is eliminated and a lighter construction is feasible. Also, the need for flame paths is eliminated in Class II equipment.

**Fast Fact:** Class I, Division 1 equipment is called “explosion proof” while Class II equipment is called “dust-ignition proof”.

Class II equipment must be designed with the following in mind:

- It must seal out the dust.
- It must operate below the ignition temperature of the hazardous substance.
- It must allow for a dust blanket.

**Fast Fact:** The build-up of dust collecting on top of the device can cause it to run "hot" and ignite the surrounding atmosphere. Class II equipment must be able to accommodate for this “dust blanket”



### Class III Requirements

For Class III equipment the concern is ignitable fibers and flyings in the work environment. Like the Class II designation the concern is not heavy explosions, but instead the ignition of the materials in the work environment.

Based on this fact there is very little difference in the design from Class II to Class III equipment.

Some equipment has been designed and is suitable for all three classifications. For instance a Class I device which could contain an explosion of a gas or vapor would also have to prevent dust from entering the enclosure to be suitable for Class II.

The close tolerance of the flame path in a Class I enclosure would also close enough to exclude explosive dust so that a gasket would not be needed. Always refer to the designation stamped on the equipment to ensure its suitability for the hazardous location you are working with.

### **Sealing of Equipment**

Proper installation of hazardous location equipment calls for the use of seals. Special fittings are required to keep hot gases from traveling through the conduit system igniting other areas if an internal explosion occurs in a Class I device.

They are also needed in certain situations to keep flammable dusts from entering dust-ignition-proof enclosures through the conduit. As shown in the figure below, when arcs and sparks cause ignition of flammable gases and vapors, the equipment contains the explosion and vents only cool gases into the surrounding hazardous area.

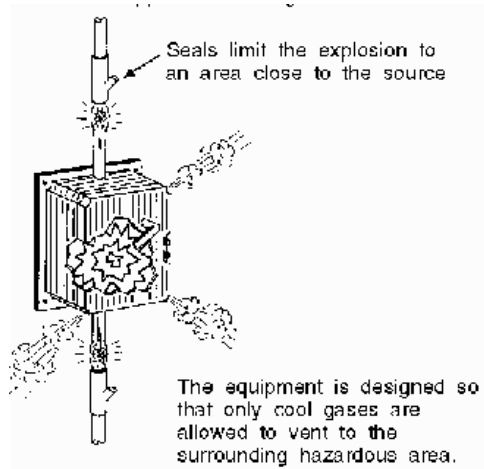

After pulling the wires through the conduit, fitting and enclosures, the electrician would fill the fitting with a chemical compound that hardens and effectively seals the passageway from dusts and gases.

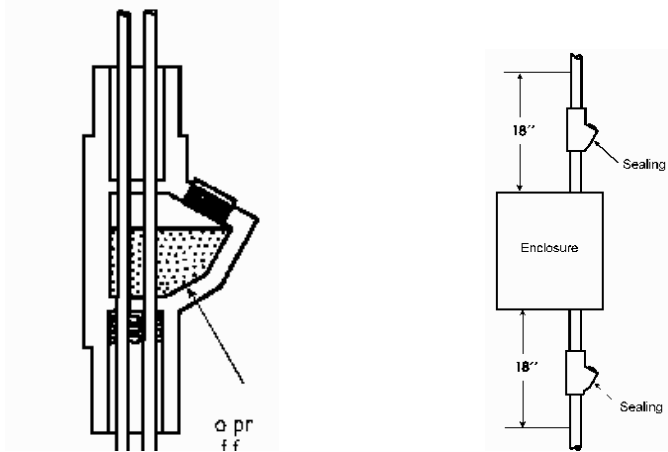

In Class I locations each conduit run entering an enclosure for switches, circuit breakers, fuses, relays, resistors, or other apparatus which may produce arcs, sparks, or high temperatures, conduit seals shall be placed as close as practicable and in no case more than 18 inches (457 mm) from such enclosures.

**Fast Fact:** Class I equipment must be explosion proof and the standard requires that the enclosure resist four times the maximum pressure expected in the hazardous location.

For instance if explosion testing shows a maximum pressure for a junction box of 250 pounds per square inch (psi), to get approval, the box must be able to withstand 1,000 psi of hydrostatic pressure - FOUR TIMES the maximum anticipated pressure of 250 psi.



## Wiring Methods and GFCI

### Protecting Employees

To protect employees from electrical shock various wiring methods circuit interrupters have been developed and must be used in the workplace. OSHA has written specific rules and equipment requirements designed to protect employees. In this section we will identify some of the most common compliance issues.

### What is a GFCI

A ground-fault circuit-interrupter (GFCI) is a protective device that compares the amount of current going into electrical equipment with the amount of current returning from the equipment and if a targeted deviation (0.005 amperes) is exceeded, the circuit is quickly broken, often within as little as 25 milliseconds.

The GFCI has proven over time to protect employees from electrical shock. During the late 1970's OSHA determined that GFCI use would be mandatory for 120-volt, single-phase, 15- and 20-ampere temporary receptacle outlets used on construction sites (1926.404(b)(1)). During this time OSHA estimates that between about 650 and 1,100 lives have been saved because of it.

GFCI's can be installed permanently (i.e. GFCI receptacle) or used temporarily to protect workers while performing certain tasks.

**Fast Fact:** Since the OSHA standard requiring GFCI use in the construction industry has been passed between 650 and 1,100 lives have been saved

### Where are Temporary GFCI's Required

On a construction site the presence of electrical hazards are very prevalent. A worker could be using a electric drill that is connected to an flexible cord set (extension cord). This cord set travels 100' where the plug head is inserted into a temporary power box.





Since the construction activities may be outside in an unprotected environment, the cord set may become damaged (i.e. insulated jacket broken), be exposed to moisture or travel through standing water.

To protect workers in this construction environment, OSHA has created rules that require GFCI use for 120-volt, single-phase, 15- and 20-ampere temporary receptacle outlets used on construction sites [see 1926.404(b)(1)]

In a non-construction (general industry) environment, employees are often exposed to the same ground-fault hazards as those associated with temporary receptacle outlets on construction sites.

Therefore, in 2007 OSHA has extended the ground-fault protection requirement to temporary receptacles used in construction-like activities performed in general industry. (see 1910.304(b)(3)(ii))

This new level of protection covers all receptacle outlets on temporary wiring installations that are used during maintenance, remodeling, or repair of buildings, structures, or equipment, or during similar construction like activities. Such activities include cleanup, disaster remediation, and restoration of large electrical installations. [see (1910.304(b)(3)(ii))]

**Fast Fact:** An example of a “construction-like” activity would be a worker laying ceramic tile in a lobby of a bank building. The worker is using a drill with a paddle to mix the mortar. The drill is connected to an extension cord which is plugged into a nearby receptacle. This activity is construction-like in nature and therefore would require a GFCI receptacle or an extension cord with built-in GFCI capabilities.

### **Where are Permanent GFCI’s Required**

Cord sets and receptacles in wet environments can potentially expose employees to severe ground-fault hazards. Therefore, in a built environment (non-construction) OSHA requires ground-fault circuit protection for all 125-volt, single-phase, 15- and 20-ampere receptacles installed in bathrooms and on rooftops. [see 1910.304(b)(3)(i)]

This new provision only applies to installations made after the effective date of OSHA’s final rule. (August 13, 2007)



## What About Protection on Other Systems

OSHA regulations extend protection to temporary wiring receptacles of higher voltage and current ratings (such as 125-volt, single-phase, 30-ampere and 480-volt, three-phase receptacles).

It better protects employees from ground-fault hazards than the construction rule because it covers other equipment that is just as subject to damage as 120-volt, single-phase, 15- and 20-ampere equipment and that is more prevalent today than when the construction rule was promulgated over 28 years ago.

## Are Extension Cords Allowable by OSHA

This question comes up frequently and yes extension cords (flexible cord sets) are allowable for use in both construction and general industry environments. However, OSHA does have certain rules that must be followed when using extension cords.

### Permitted Use of Flexible Cords

Flexible cords and cables may be used only for [see 1910.305(g)(1)(ii)(A) – (F)]:

- pendants
- wiring of fixtures
- connection of portable lamps or appliances
- portable and mobile signs
- elevator cables
- wiring of cranes and hoists
- appliances to permit removal for maintenance and repair

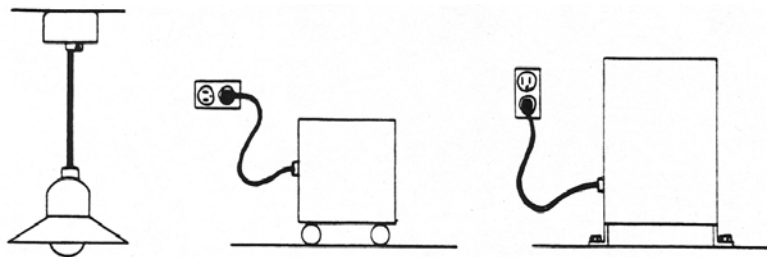

## Prohibited Use of Flexible Cords:

Common OSHA violations when using an extension cord include the following [see 1910.305(g)(1)(iv)(A) – (D)]:

- As substitute for fixed wiring
- Run through walls, ceilings, or floors
- Run through doorways, windows
- Attached to building surfaces

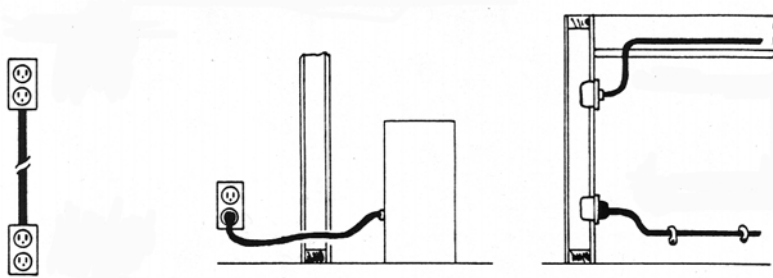

## Inspections of Extension Cords

Since extension cords are exposed to damage they must be visually inspected before use on any shift for both external and internal defects.

External defects include:

- deformed pins
- missing grounding pins
- damage to outer jacket or insulation
- loose plug head

Internal damage may be present if:

- pinched outer jacket
- crushed outer jacket
- broken plug head
- use of duct tape or electrical tape if present



Additionally prior to using an extension cord, the employee must examine the outer jacket to determine if the cord is adequate for the load.

Cord and plug connected equipment and flexible cord sets (extension cords) which remain connected once they are put in place and are not exposed to damage need not be visually inspected until they are relocated.

### **Overcurrent Protection Devices**

Overcurrent protection such as circuit breakers are an effective way to reduce the damage done by a fault in the electric circuit. For instance, in the event of a fault, a circuit breaker would trip and within a fraction of a second isolate the fault. If this overcurrent protection device were not present, damage to the system could occur (such as fire) and damage to vital (and expensive) equipment.

**Fast Fact:** Circuit breakers are designed to protect equipment – not people. Relying on a circuit breaker to trip as a means to protect an employee from electrocution is a deadly mistake!

Remember - as important as a circuit breaker might be, they are not designed to protect employees from electrical shock, but they are critical in reducing secondary damage in the event of a fault. Because of their critical nature, OSHA regulations establish that overcurrent protection devices shall be readily accessible to building management personnel. In addition to being readily accessible, overcurrent protection devices must be labeled as to their purpose and clearly indicate whether they are in the on or off position. If a protection device is installed vertically, the up position shall indicate "On".

Often times, direct and quick access to overcurrent protection devices (i.e. circuit breakers) is not possible due to stored materials in front of the protection device. To combat this common problem, OSHA has determined that "working space" adjacent to the protection device may not be used for storage and must remain clear at all times. [see 1910.303(g)(1)(ii)]

OSHA provides a table which identifies the required working space in front protection devices based on voltage levels and installation conditions. [see 1910.303(g)(1)(i)(A)]



Table S-1. -- Minimum Depth of Clear Working Space at Electric Equipment, 600 V or Less

Nominal voltage to ground	Minimum clear distance for condition <sup>2 3</sup>					
	Condition A		Condition B		Condition C	
	m	ft	m	ft	m	ft
0-150	<sup>1</sup> 0.9	<sup>1</sup> 3.0	<sup>1</sup> 0.9	<sup>1</sup> 3.0	0.9	3.0
151-600	<sup>1</sup> 0.9	<sup>1</sup> 3.0	1.0	3.5	1.2	4.0

Notes to Table S-1:

1. Minimum clear distances may be 0.7 m (2.5 ft) for installations built before April 16, 1981.

2. Conditions A, B, and C are as follows:

Condition A -- Exposed live parts on one side and no live or grounded parts on the other side of the working space, or exposed live parts on both sides effectively guarded by suitable wood or other insulating material. Insulated wire or insulated busbars operating at not over 300 volts are not considered live parts.

Condition B -- Exposed live parts on one side and grounded parts on the other side.

Condition C -- Exposed live parts on both sides of the work space (not guarded as provided in Condition A) with the operator between.

3. Working space is not required in back of assemblies such as dead-front switchboards or motor control centers where there are no renewable or adjustable parts (such as fuses or switches) on the back and where all connections are accessible from locations other than the back. Where rear access is required to work on deenergized parts on the back of enclosed equipment, a minimum working space of 762 mm (30 in.) horizontally shall be provided.

**Fast Fact:** Working space distances shall be measured from the live parts if they are exposed or from the enclosure front or opening if they are enclosed.



## Disconnecting Means of Motors

When working with electrical motors, extra caution shall be given to the disconnection means. The disconnecting means for the motor shall be “within sight of” the motor. OSHA has determined that “within sight” means within 50’.

Additionally, the disconnecting means shall be readily accessible and plainly indicate whether it is in the open (off) or closed (on) position.

If more than one disconnect is provided for the same equipment, only one disconnecting means need be readily accessible.

[see 1910.305(j)(4)(i) and (iv) – (v)]

**Fast Fact:** When a circuit breaker is used as a switch (i.e. stadium lighting) the circuit breaker must be labeled as “SWD” and identify what lighting it controls.

## Cabinets, Boxes and Fittings

Another frequent safety issue and common OSHA violation concerns pull boxes, cabinets, junction boxes and fittings. These items can become a “weak link” in the electrical circuit due to a number of different root causes.

Conductors entering cutout boxes, cabinets, or fittings shall be protected from abrasion, and openings through which conductors enter shall be effectively closed. [see 1910.305(b)(1)(i)]

All pull boxes, junction boxes, and fittings shall be provided with covers and if covers are metal they must be grounded. [see 1910.305(b)(2)(i)]

## Other Prohibited Wiring Uses

No wiring systems of any type may be installed in ducts used to transport dust, loose stock, or flammable vapors. No wiring system of any type may be installed in any duct used for vapor removal or for ventilation of commercial-type cooking equipment, or in any shaft containing only such ducts. [see 1910.305(a)(1)(iii)]



## **Temporary Power and Lighting**

There does exist circumstances where temporary power and lighting is needed for an extended period of time and OSHA has made allowances for these circumstances.

Temporary power and lighting may be used for Christmas lighting, carnivals, etc. however the duration of time shall not exceed 90 days. This rule is also applicable to experimental work and emergencies.





# WORKPLACE SAFETY

A W A R E N E S S C O U N C I L

**Like to Learn More?**

**Visit the  
Workplace Safety Awareness Council  
[www.wpsac.org](http://www.wpsac.org)**

**For OSHA compliance seminars,  
webinars and teleconferences**